

LION

SOLAR POWER & LIGHTING

2017

SOLAR LED LIGHT “Hyperion”



LION SOLAR POWER & LIGHTING

Julphar Commercial Tower, Office No:912, 9th Floor

Ras Al Khaimah United Arab Emirates

Solarlightuae.com, lionsolaruae.com

info@greencrystalsolar.com support@lionsolaruae.com

+971 50 499 8956 , +971 55 499 8700

Product introduction

The solar led street lamp is researched and developed by the Nomo Group Co.Ltd. It's wireless and easy to be installed, with the free maintenance and long working life.

Popular uses

For small streets, parking lots, arenas, public spaces, yards, open areas and other roadway lighting etc.

Product features

Integrated design, beautiful, simple and convenient

Solar power supply, green environmental protection, zero emissions

Using new long-life battery, lithium iron phosphate, the free maintenance for 5-8 years

The multiple function controller, a variety of models for your choice

More energy saving and lighting for longer

LG Chip, high photosynthetic efficiency, long life

Surface anti-corrosion treatment, salt fog 480 h does not rust.

1. Size of products

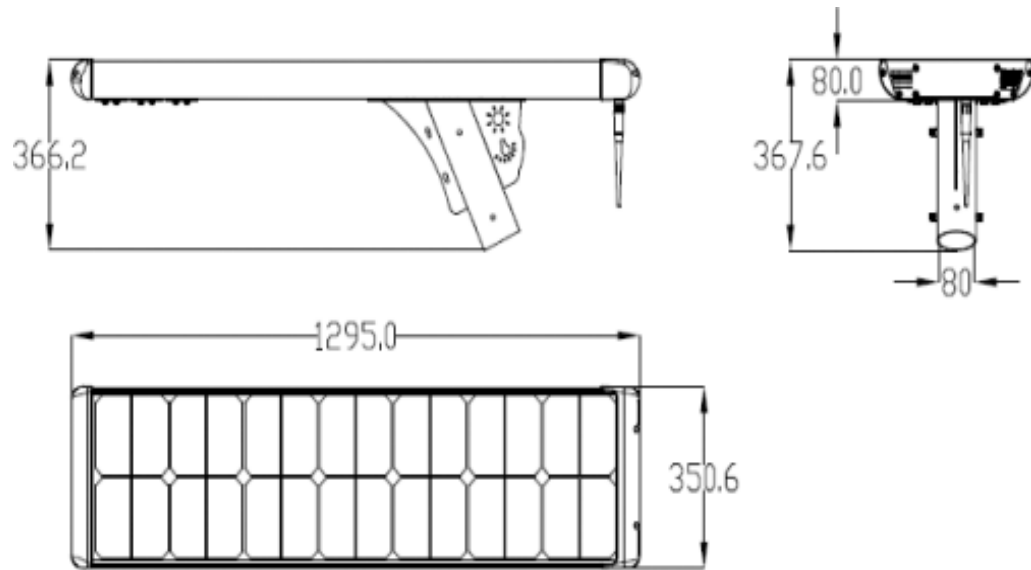

2. Specification

MODEL	Hyperion- 4000LM
Parameters	
PV Module	90W
Life time	25 years (The power attenuation of each year is around 1%)
LED luminous	4000LM
LED chip	3535 LED
viewing Angel	70°*140°
Color Temperature	3000K-6500K, Typical (5500K-6000K)
Color rendering index	>70
Life time	>5years
Battery Tape	LiFePo4 battery
Battery Capacity	346WH
Battery life time	(5-8years)

MPPT charge controller	including wireless communication module (please see the Communication topology below)
Timing mode	1Hr50% ,4Hr100%,3Hr50%,4Hr25%.
	Infrared induction is optional
Circuit Protection	Overcharge, discharge, short circuit, open load, lightning protection and other functions
Life time	5-8years
Charging Time (STC)	6-8Hours(With STC)
Certificate	CE、ROSH、IP65
Working Temperature	-20°C~+60°C(When the temperature is below -10°C, derating use)
Storage Temperature	0°C~45°C
Protection Grade	IP67
Dimension Size(mm)	1295*350*80mm
Installation Height	5 m to 7m light pole
Installation Diameter	<80mm
Clearance of Installation	20m to 25m

3. Working mode

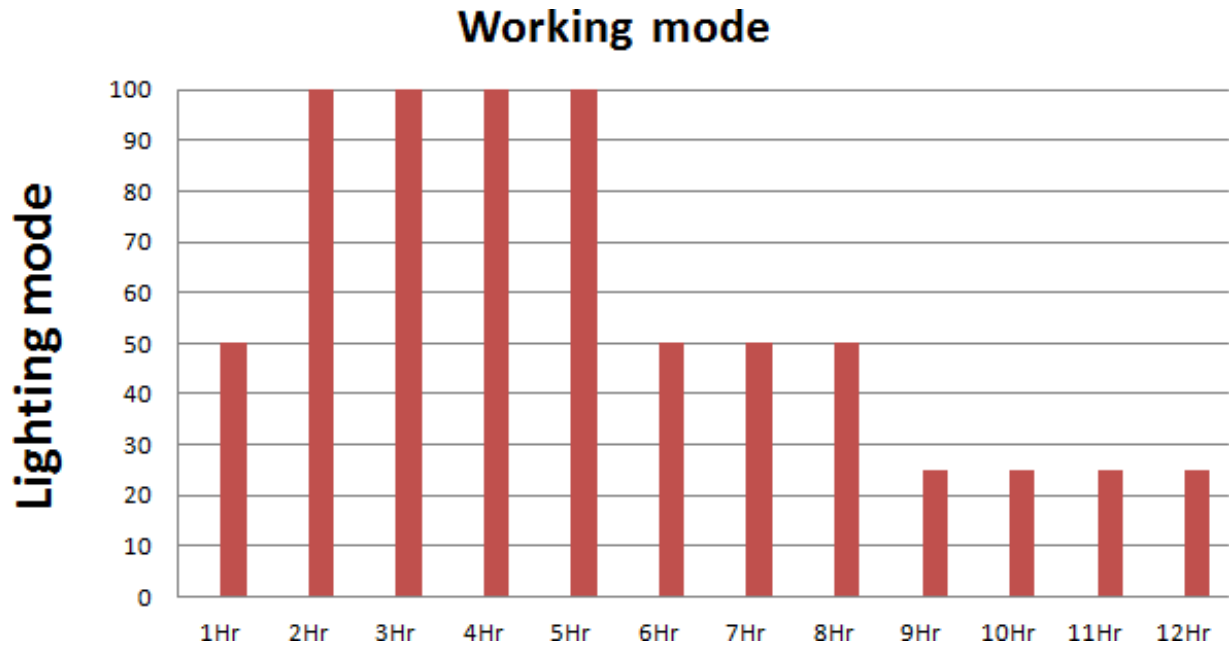

4. Light Distribution

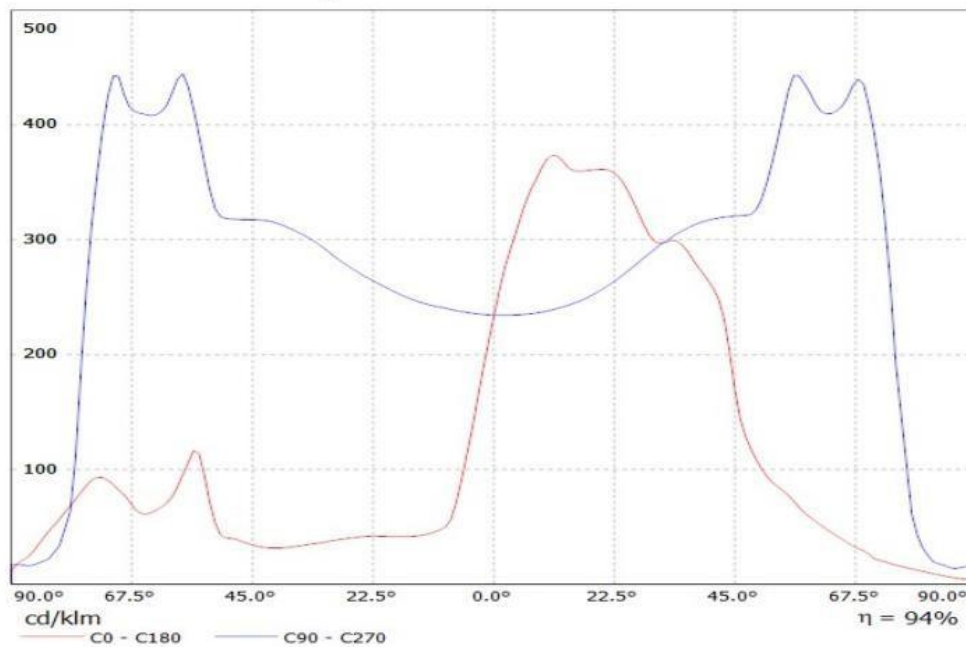

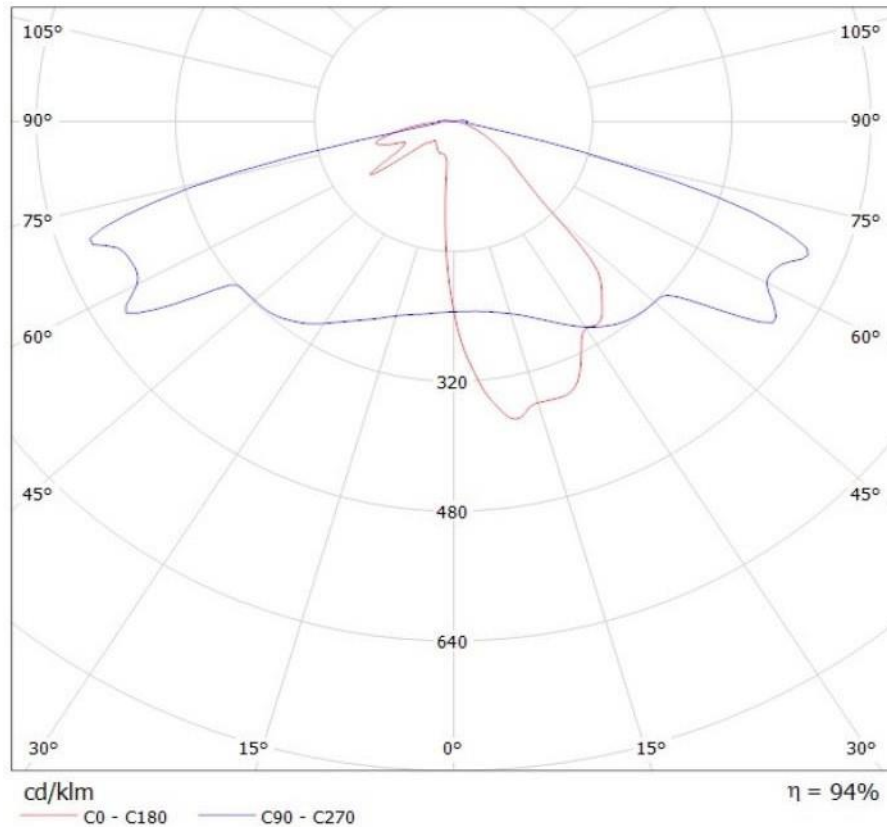

5. Adaptive road type simulation

Height: 8m, width:8m,pole distance; 30m , lighting arrange on one side ,simulated data

DIALux

Roadway 1 (ME4a)

Horizontal illuminance [lx]

7.333	16	15	15	15	16	16	16	16	15	16
6.000	21	19	18	18	18	18	18	19	20	21
4.667	26	23	20	17	17	17	18	21	23	26
3.333	30	26	21	16	14	15	16	22	27	30
2.000	26	22	18	13	12	13	13	18	22	25
0.667	7.77	8.47	9.85	9.38	10	11	9.27	9.65	8.76	8.10
m	1.250	3.750	6.250	8.750	11.250	13.750	16.250	18.750	21.250	23.750

Grid: 10 x 6 Points

EAvg [lx]	EMin [lx]	EMax [lx]	g1	g2
17	7.77	30	0.446	0.257