



# LION

SOLAR POWER & LIGHTING

## LION SOLAR POWER & LIGHTING

Julphar Commercial Tower, Office No:912, 9<sup>th</sup> Floor

Ras Al Khaimah United Arab Emirates

[Solarlightuae.com](http://Solarlightuae.com), [lionsolaruae.com](http://lionsolaruae.com)

[info@greencrystalsolar.com](mailto:info@greencrystalsolar.com) [support@lionsolaruae.com](mailto:support@lionsolaruae.com)

+971 50 499 8956 , +971 55 499 8700

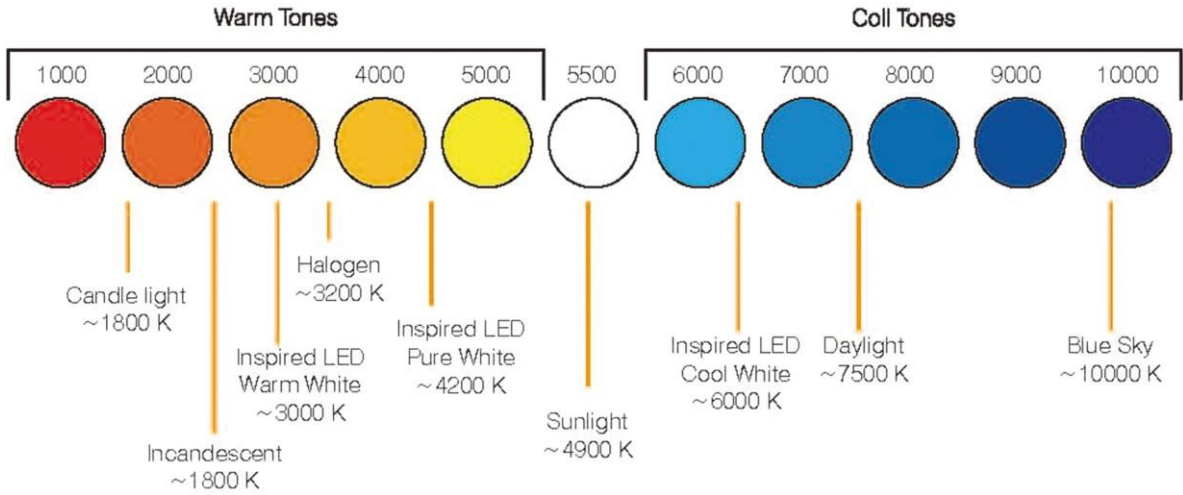

**PHILIPS**

**TRIDONIC**  
enlightening your ideas

**OSRAM**

**HEP** power for light™



## Spot Light



P1



P1



P1



P1



P2



P4



P5



P6

## Down Light(Recessed)



P7



P8



P10

## Down Light(Surface)



P11



P12



P13



P14



P15



P16



P17

## Track Light



P18



P19



P20



P21

## Accessories



# Spot Light



I-SP-1



I-SP-3



I-SP-2



I-SP-4

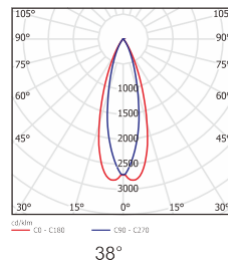
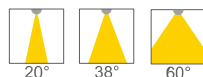
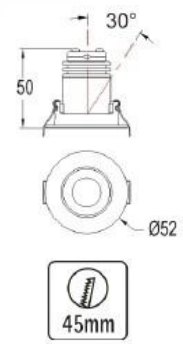
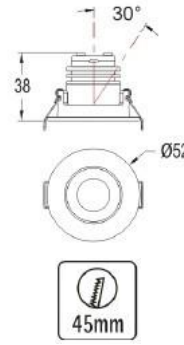
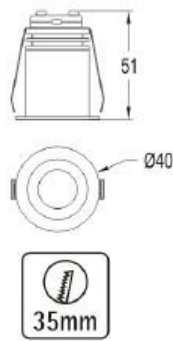
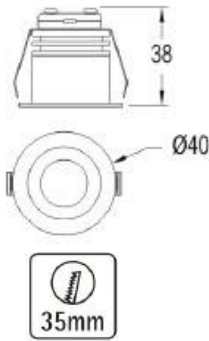

### Material

Die-cast Aluminium housing and heat sink

### Surface Colour



White RAL9003  
Black RAL9004

### Applications

Hotels  
Retail stores  
Residential lighting  
Cabinets

La Model	Power	LED Chip	Color Temp.	Lumens lm(4000K)	Beam Angle	CRI
I-SP-1	4.5W	Cree	3000K/4000K/5000K	200lm	20°/38°/60°	80/90
I-SP-2	4.5W	Cree	3000K/4000K/5000K	200lm	20°/38°/60°	80/90
I-SP-3	4.5W	Cree	3000K/4000K/5000K	200lm	20°/38°/60°	80/90
I-SP-4	4.5W	Cree	3000K/4000K/5000K	200lm	20°/38°/60°	80/90

# Spot Light



110-240V



30000H

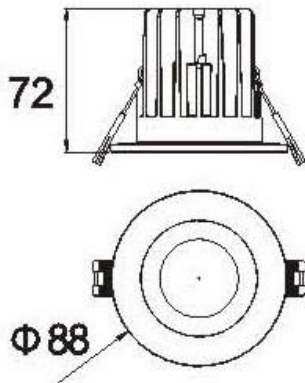
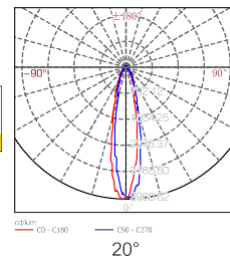

#### Material

Die-cast Aluminium housing and heat sink

#### Surface Colour



White RAL9003    Black RAL9004

#### Applications

Hotels  
Retail stores  
Residential lighting  
Cabinets

La Model	Power	LED Chip	Color Temp.	Lumens lm(4000K)	Beam Angle	CRI
I-SP-5 IP65	11W	Cree	2700K/3000K/4000K/5000K	950lm	20°/40°/55°	80/90

# Spot Light

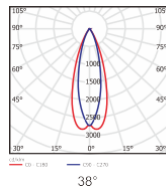

### Material

Die-cast Aluminium housing and heat sink

### Surface Colour



### Applications

Hotels  
Retail stores  
Residential lighting  
Cabinets

La Model	Power	LED Chip	Color Temp.	Lumens lm(4000K)	Beam Angle	CRI
I-M-1	11W	Cree	2700K/3000K/4000K/5000K	1000lm	15°/24°/38°/60°	80/90
I-M-1R	-	-	-	-	-	-
I-M-1S	-	-	-	-	-	-

# Spot Light

I-M-2

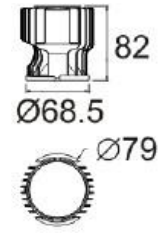

I-M-2R

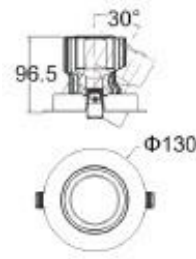

I-M-2S

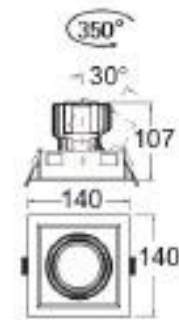

**Material**

Die-cast Aluminium housing and heat sink

**Surface Colour**



**Applications**

- Hotels
- Retail stores
- Residential lighting
- Cabinets

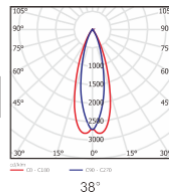

La Model	Power	LED Chip	Color Temp.	Lumens lm(4000K)	Beam Angle	CRI
I-M-2	25W	Cree Philips	2700K/3000K/4000K/5000K	2500lm	12°/15°/24°/38°/60°	80/90
I-M-2R	-	-	-	-	-	-
I-M-2S	-	-	-	-	-	-

# Spot Light

I-M-3

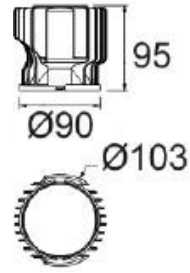

I-M-3R

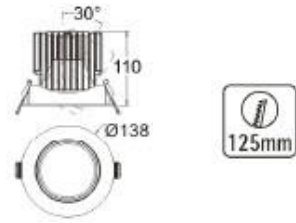

I-M-3S

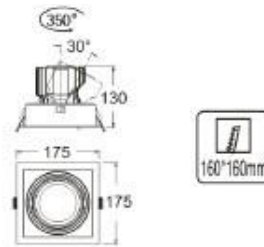

#### Material

Die-cast Aluminium housing and heat sink

#### Surface Colour



#### Applications

Hotels  
Retail stores  
Residential lighting  
Cabinets

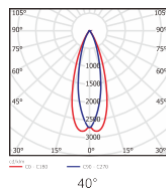

La Model	Power	LED Chip	Color Temp.	Lumens lm(4000K)	Beam Angle	CRI
I-M-3	35W	Cree Philips	2700K/3000K/4000K/5000K	3150lm	10°/15°/24°/40°/60°	80/90
I-M-3R	-	-	-	-	-	-
I-M-3S	-	-	-	-	-	-



# Spot Light

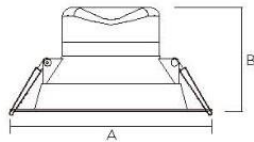
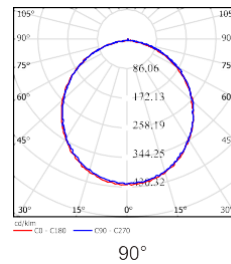

Watts	A	B	Cut-out
5W	Ø92mm	64mm	Ø68-80mm
8W	Ø113mm	73mm	Ø90-102mm
12W	Ø145mm	75mm	Ø120-130mm
17W	Ø174mm	79mm	Ø145-155mm
25W	Ø244mm	95mm	Ø195-210mm

#### Material

PBT+PS

#### Surface Colour



White  
RAL9003

#### Applications

Bathrooms  
Toilets  
Under canopy  
Residential hallways

La Model	Power	LED Chip	Color Temp.	Lumens lm(4000K)	Beam Angle	CRI
I-DR-1	5W	Sanan	3000K/4000K/5000K	450lm	90°	80/90
	8W	Sanan	3000K/4000K/5000K	660lm	90°	80/90
	12W	Sanan	3000K/4000K/5000K	1100lm	90°	80/90
	17W	Sanan	3000K/4000K/5000K	1600lm	90°	80/90
	25W	Sanan	3000K/4000K/5000K	2400lm	90°	80/90

# Down Light-Recessed

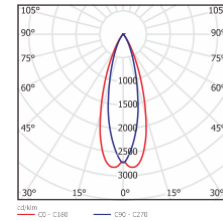

33°

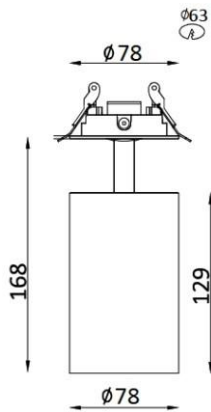

## Material

Die-cast Aluminium housing and heat sink

## Surface Colour



White RAL9003    Black RAL9004

## Applications

Hotels  
Retail stores  
Residential lighting  
Cabinets

La Model	Power	LED Chip	Color Temp.	Lumens lm(4000K)	Beam Angle	CRI
I-DR-2	35W	Lumileds	2700K/3000K/4000K/5000K	3150lm	23°/33°/43°	80/90

# Down Light

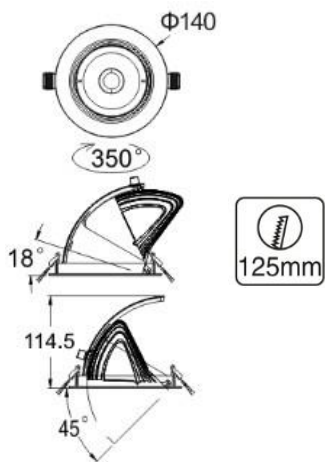
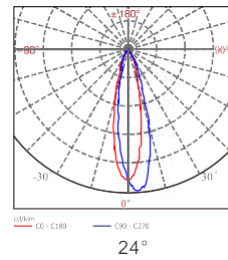

## Material

Die-cast Aluminium housing and heat sink

## Surface Colour



White RAL9003    Black RAL9004

## Applications

Hotels  
Retail stores  
Residential lighting  
Cabinets

La Model	Power	LED Chip	Color Temp.	Lumens lm(4000K)	Beam Angle	CRI
I-DR-3	25W	Cree	2700K/3000K/4000K/5000K	1900lm	15°/24°/38°	80/90

# Down Light-Surface

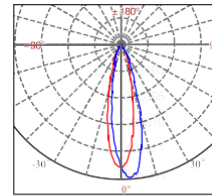

25°

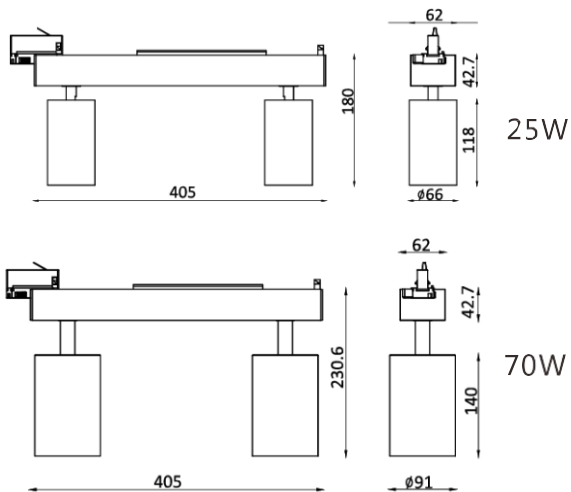

## Material

Die-cast Aluminium housing and heat sink

## Surface Colour



White RAL9003 Black RAL9004

## Applications

Hotels  
Retail stores  
Residential lighting  
Cabinets

La Model	Power	LED Chip	Color Temp.	Lumens lm(4000K)	Beam Angle	CRI
I-DS-1	9.5WX2=25W	Bridgelux	2700K/3000K/4000K/5000K	550lmX2	15°/25°/35°	80/90
	31WX2=70W	Lumileds	2700K/3000K/4000K/5000K	3150lmX2	23°/33°/43°	80/90

# Down Light-Surface

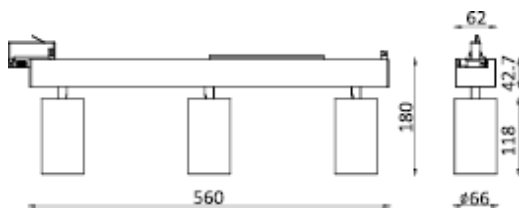
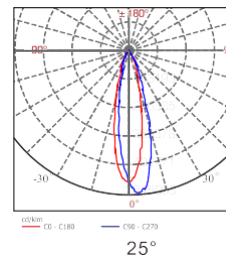

## Material

Die-cast Aluminium housing and heat sink

## Surface Colour



White RAL9003    Black RAL9004

## Applications

Hotels  
Retail stores  
Residential lighting  
Cabinets

La Model	Power	LED Chip	Color Temp.	Lumens lm(4000K)	Beam Angle	CRI
I-DS-2	7.2WX3=27W	Bridgelux	2700K/3000K/4000K/5000K	450lmX3	15°/25°/35°	80/90
	12.5WX3=45W	Bridgelux	2700K/3000K/4000K/5000K	1000lmX3	15°/25°/35°	80/90

# Down Light-Surface

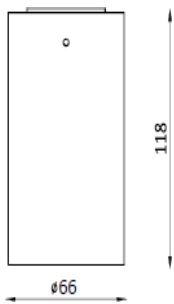
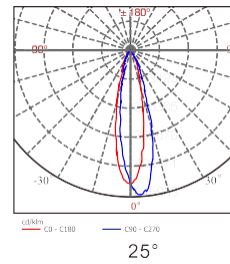

9W

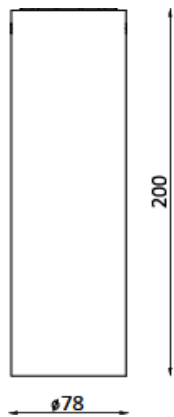

15W

### Material

Die-cast Aluminium housing and heat sink

### Surface Colour



White RAL9003    Black RAL9004

### Applications

- Hotels
- Retail stores
- Residential lighting
- Cabinets

La Model	Power	LED Chip	Color Temp.	Lumens lm(4000K)	Beam Angle	CRI
I-DS-3R	9W	Bridgelux	2700K/3000K/4000K/5000K	450lm	15°/25°/35°	80/90
	15W	Bridgelux	2700K/3000K/4000K/5000K	1000lm	15°/25°/35°	80/90

# Down Light-Surface

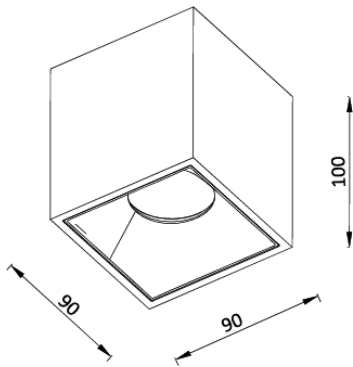
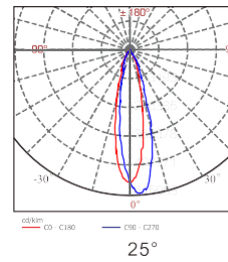
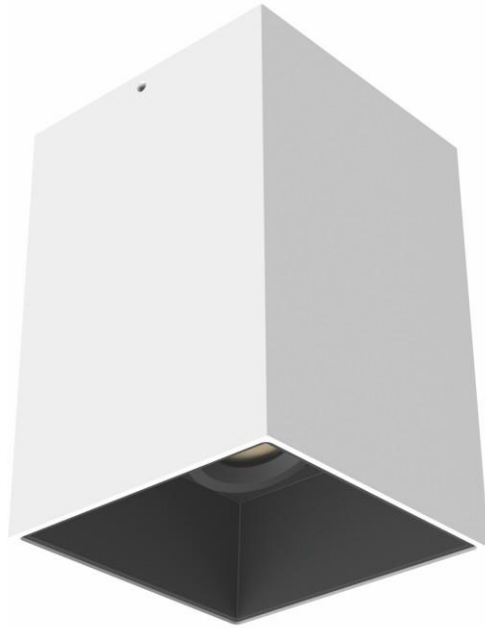

## Material

Die-cast Aluminium housing and heat sink

## Surface Colour



White RAL9003    Black RAL9004

## Applications

Hotels  
Retail stores  
Residential lighting  
Cabinets

La Model	Power	LED Chip	Color Temp.	Lumens lm(4000K)	Beam Angle	CRI
I-DS-3S	9W	Bridgelux	2700K/3000K/4000K/5000K	450lm	15°/25°/35°	80/90
	15W	Bridgelux	2700K/3000K/4000K/5000K	1000lm	15°/25°/35°	80/90

# Down Light-Surface

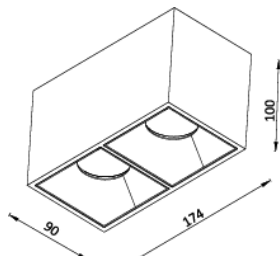
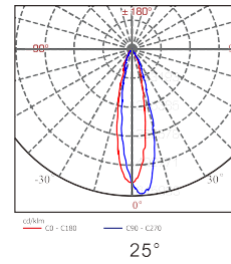

Honeycomb



Square front cover



Square Gap front cover



## Material

Die-cast Aluminium housing and heat sink

## Surface Colour



White

Black

RAL9003

RAL9004

## Applications

Hotels  
Retail stores  
Residential lighting  
Cabinets

La Model	Power	LED Chip	Color Temp.	Lumens lm(4000K)	Beam Angle	CRI
I-DS-4S	6WX2=18W	Bridgelux	2700K/3000K/4000K/5000K	450lmX2	15°/25°/35°	80/90
	12WX2=30W	Bridgelux	2700K/3000K/4000K/5000K	1000lmX2	15°/25°/35°	80/90



# Down Light-Surface

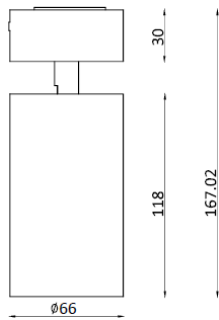
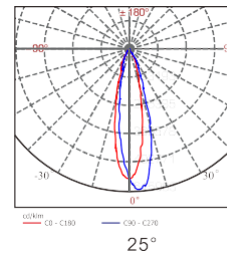

9W

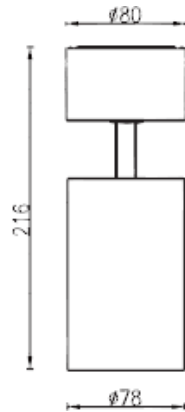

20W

### Material

Die-cast Aluminium housing and heat sink

### Surface Colour



White RAL9003    Black RAL9004

### Applications

Hotels  
Retail stores  
Residential lighting  
Cabinets

La Model	Power	LED Chip	Color Temp.	Lumens lm(4000K)	Beam Angle	CRI
I-DS-5	9W	Bridgelux	2700K/3000K/4000K/5000K	450lm	15°/25°/35°	80/90
	20W	Lumileds	2700K/3000K/4000K/5000K	1500lm	25°/35°/45°	80/90

# Pendent Light

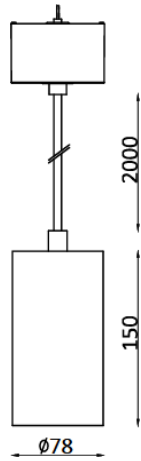
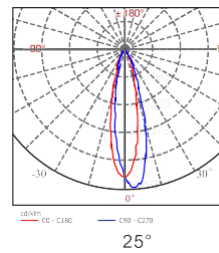

## Material

Die-cast Aluminium housing and heat sink

## Surface Colour



White

Black

RAL9003

RAL9004

## Applications

Hotels  
Retail stores  
Residential lighting  
Cabinets

La Model	Power	LED Chip	Color Temp.	Lumens lm(4000K)	Beam Angle	CRI
I-DS-6	12W	Bridgelux	2700K/3000K/4000K/5000K	550lm	15°/25°/35°	80/90

# Track Light



110-240V

CE

IP20

30000H

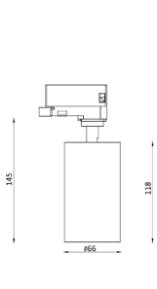
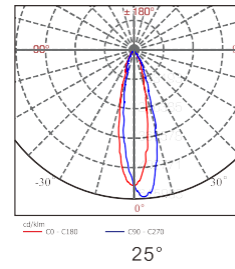

9W

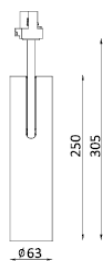

15W

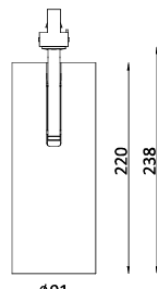

35W

## Material

Die-cast Aluminium housing and heat sink

## Surface Colour



White

Black

RAL9003

RAL9004

## Applications

Hotels  
Shopping malls  
Retail stores  
Bars

La Model	Power	LED Chip	Color Temp.	Lumens lm(4000K)	Beam Angle	CRI
I-T-1	9W	Bridgelux	2700K/3000K/4000K/5000K	450lm	15°/25°/35°	80/90
	15W	Bridgelux	2700K/3000K/4000K/5000K	1000lm	15°/25°/35°	80/90
	35W	Lumileds	2700K/3000K/4000K/5000K	3150lm	23°/33°/43°	80/90

# Track Light

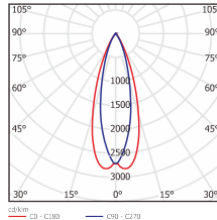

33°

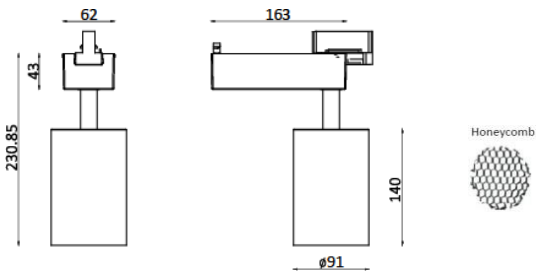

### Material

Die-cast Aluminium housing and heat sink

### Surface Colour



White RAL9003 Black RAL9004

### Applications

Hotels  
Shopping malls  
Retail stores  
Bars

La Model	Power	LED Chip	Color Temp.	Lumens lm(4000K)	Beam Angle	CRI
I-T-2	35W	Lumileds	2700K/3000K/4000K/5000K	3150lm	23°/33°/43°	80/90

# Track Light

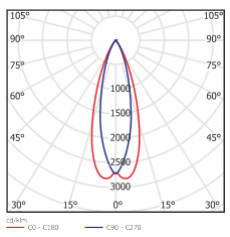

33°

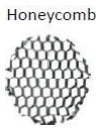
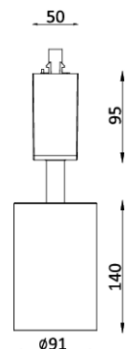
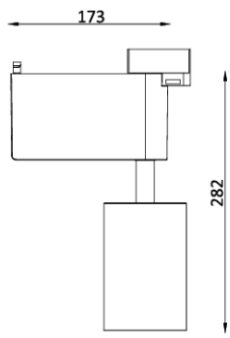

**Material**

Die-cast Aluminium housing and heat sink

**Surface Colour**



White RAL9003    Black RAL9004

**Applications**

- Hotels
- Shopping malls
- Retail stores
- Bars

La Model	Power	LED Chip	Color Temp.	Lumens lm(4000K)	Beam Angle	CRI
IT-3	35W	Lumileds	2700K/3000K/4000K/5000K	3150lm	23°/33°/43°	80/90

# Track Light

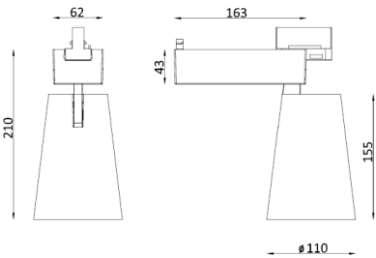
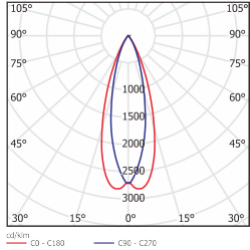

Honeycomb



**Material**

Die-cast Aluminium housing and heat sink

**Surface Colour**



White RAL9003    Black RAL9004

**Applications**

- Hotels
- Shopping malls
- Retail stores
- Bars

La Model	Power	LED Chip	Color Temp.	Lumens lm(4000K)	Beam Angle	CRI
I-T-4	35W	Lumileds	2700K/3000K/4000K/5000K	3150lm	17°/25°/35°/50°	80/90

# Accessories

La Model	Picture	Size mm
A-T-T3-1M(3-Wire)		1030X190X83mm
A-T-T3-1.5M(3-Wire)		1530X190X83mm
A-T-T3-2M(3-Wire)		2030X190X83mm
A-T-T4-1M(4-Wire)		1030X185X95mm
A-T-T4-1.5M(4-Wire)		1530X185X95mm
A-T-T4-2M(4-Wire)		2030X185X95mm
A-T-2		375x195x225mm
A-T-3		375x195x225mm
A-T-4		370x235x220mm
A-T-5		375x195x225mm
A-C-1		-
A-C-2		-

# IP Rating

- IPX1 Protected against vertically falling drops of water (e.g. condensation)
- IPX2 Protected against direct sprays of water up to 15 degrees from vertical
- IPX3 Protected against direct sprays of water up to 60 degrees from vertical
- IPX4 Protected against water sprays from all directions-limited ingress permitted
- IPX5 Protected against low pressure jets of water from all directions-limited ingress permitted
- IPX6 Protected against high pressure jets of water (use on ship deck)-limited ingress permitted
- IPX7 Protected against the effects of immersion between 15cm and 1m
- IPX8 Protected against long periods of immersion under pressure

 Mains voltage 12V AC/DC

 Mains voltage 100~240V AC

 Mains voltage 220V AC

 Mains voltage 220~240V AC

**CE** This mark is a declaration that the product in question meets the requirements of the applicable EU directives. In the case of lighting products this means that they comply with the Low Voltage Directive (LVD), the Electromagnetic Compatibility (EMC) Directive and the Restrictions of the Use of Certain Hazardous Substances Directive (RoHS). It is the responsibility of the lighting manufacturer to ensure that all their products that are sold in the European Economic Area carry the CE mark.

 Rated life of a product, "h" is short for hour.-Fittings must be installed in accordance with instructions and specifically not in an ambient temperature that ever exceeds 25.-Consumable items, such as fuses, batteries and lamp are excluded.-Lumen depreciation to 70% of initial lumens (L70) can occur within the stated lifetime and will not constitute a valid after service claim.